

MAC
METAL ARCHITECTURAL

PUSHING
THE ENVELOPE

SIDING
Catalog

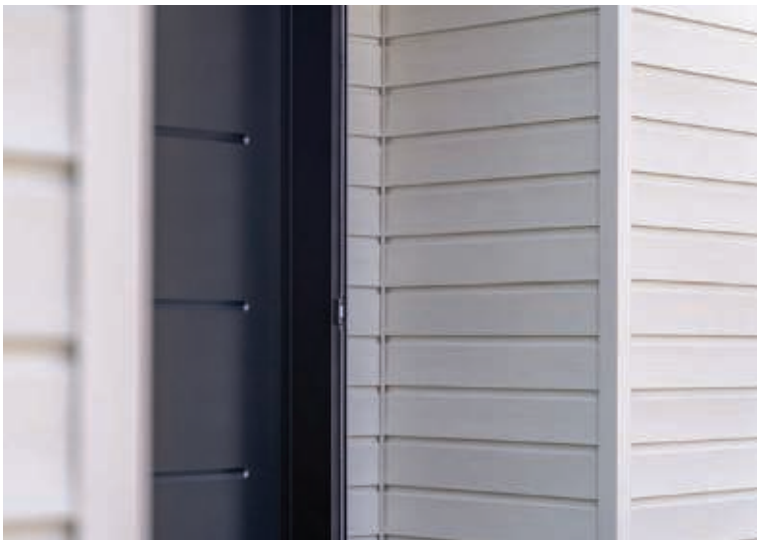

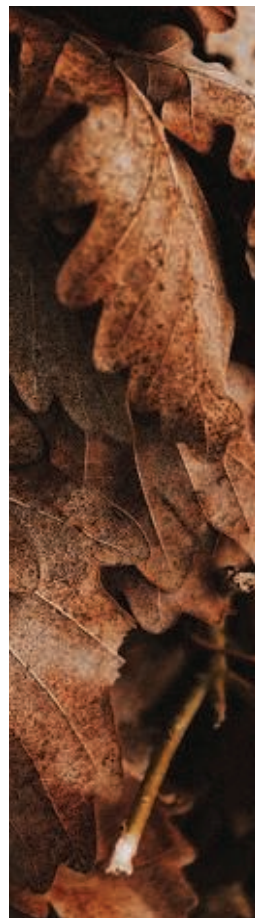

MAC

METAL ARCHITECTURAL

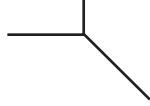

For more than 30 years, MAC has been offering its customers top-of-the-line steel cladding profiles designed and manufactured entirely in Canada. Constantly in pursuit of innovation, our company offers products with rich and unique colors, bringing style and elegance to the projects they clad.

We promise you sustainable, high-performance products that will enhance and protect your home's envelope. Backed by a 40-year warranty, they will give you peace of mind for years to come.

At MAC, we do not compromise on quality or aesthetics. We strive to offer you products that are in line with architectural trends so that they are the perfect style complement to your property. We want to help you turn your new project into the dream place you imagined.

In addition to enhancing the look and value of your home by 6–8%, MAC profiles are maintenance-free and offer impeccable, lasting beauty year after year. Discover our unique styles that will perfectly match all your projects!

LET YOURSELF BE INSPIRED!

TABLE OF CONTENTS

The look and richness of wood	4
Harrywood	6
Norwood	10
Norwood Mini	14
Harrywood Block	16
Polymac	18
Steel, an ecological choice	20
Metal Block	22
Versa	24
8 reasons to choose MAC	26
MS 1 & MS 2	28
MS Authentic	30
MS 1 Modular	32
MS 3 & MS 4	34
MS 380	36
MS 750 & MS 7501	37
The Textural System	38
Our colors	40
Accessories	42



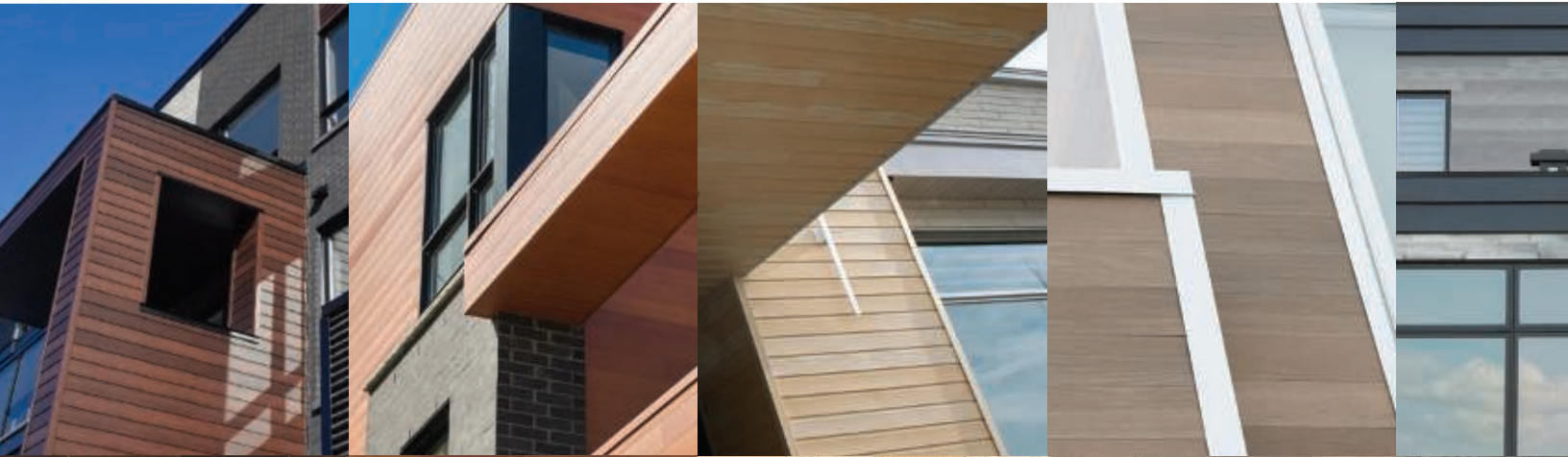

TORREFIED

CEDAR

SCANDINAVIAN FIR

SMOKED BIRCH

ASH GREY

THE LOOK AND RICHNESS OF WOOD

without the maintenance!



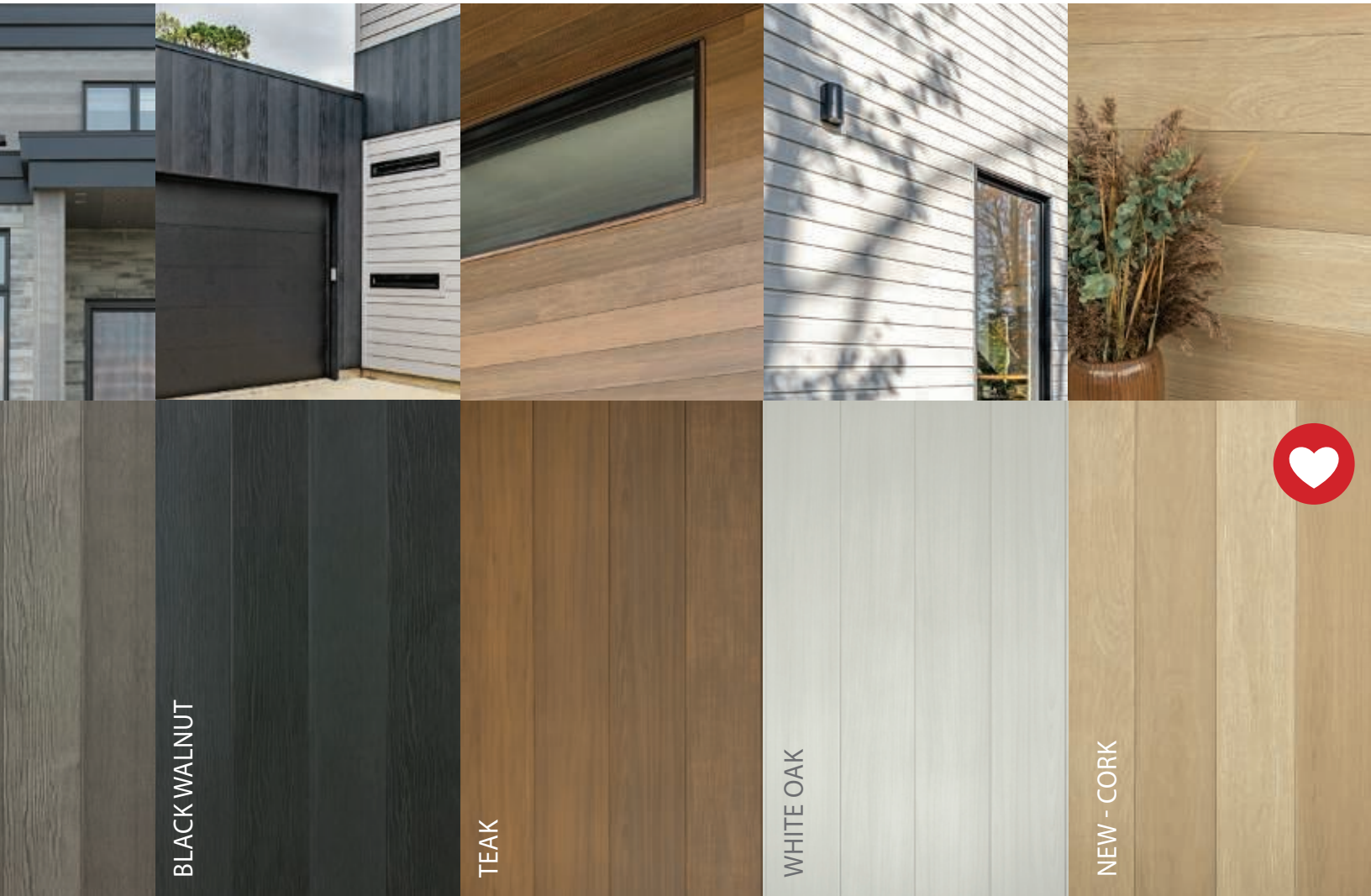

With busy schedules, we sometimes run out of the time needed to maintain our homes.

The MAC Wood Collection offers you the beauty and richness of wood without the maintenance that comes with it. As a result, you will be able to enjoy the comfort of your home for years to come.

Each color in the Wood Collection offers 6 different planks of various grains and shades, designed to recreate the look of wood and make the final result as natural as possible. Our goal is to create products with contemporary designs and colors that blend seamlessly with the environment around them.

HARRYWOOD

The look of wood,
the durability of steel!



With its European influences, this profile with its fine, clean lines will give your property its own unique signature. It will blend in perfectly with both contemporary and classic designs. Combining style, strength, and durability, it will inevitably enhance the look of your project by adding an unparalleled elegance.





HARRYWOOD



Style without compromise!

CHARACTERISTICS

- Maintenance-free
- 40-year warranty
- Robust and sustainable
- Vertical, horizontal, and diagonal installation



6 1/16" x 3/8" x 12'

AVAILABLE COLORS

WOOD COLLECTION

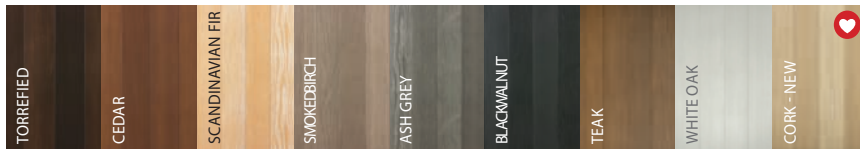

SIGNATURE COLLECTION

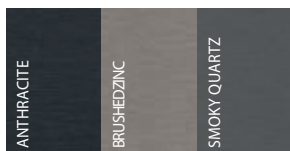

INSPIRATION COLLECTION







NORWOOD

Chic, timeless,
and maintenance-free!

Norwood's linear appearance adds an elegant touch to the architectural projects it enhances. The two-dimensional spaced plank accentuates the effect of light and shadow, adding depth to the design. Applied in any of the colors in the Wood Collection, it will add a warm, natural look to your home.





Norwood & Versa | White Oak & Titanium Black



NORWOOD

A chic and timeless look,
without maintenance!

CHARACTERISTICS

- Maintenance-free
- 40-year warranty
- Robust & sustainable
- Vertical, horizontal, and diagonal installation
- 5.38" plank



5.38" x 7/16" x 12'



AVAILABLE COLORS

WOOD COLLECTION

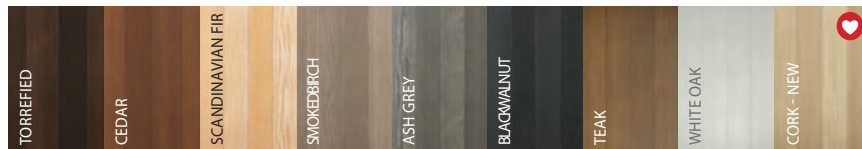

SIGNATURE COLLECTION

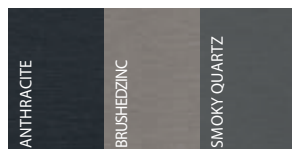

INSPIRATION COLLECTION





NORWOOD MINI

Express your creativity
with Norwood Mini



The Norwood Mini profile's two-dimensional planks combine the charm and simplicity of Scandinavian style with narrow or multi-width strips. Used alone or in combination with Norwood, the Norwood Mini provides you with multiple pattern possibilities. It is sure to add depth and a distinctive look to your project.

Here are just a few of the endless installation possibilities the Norwood Mini profile offers when combined with Norwood.



Ratio : 2 Norwood Mini
X1 Norwood

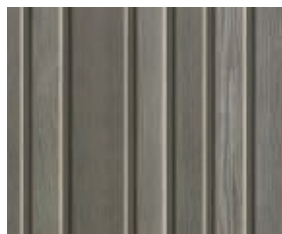

Ratio : 3 Norwood Mini
X1 Norwood

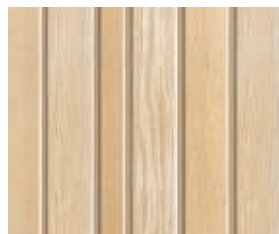

Ratio : 3 Norwood
X1 Norwood Mini

FEATURES

- Maintenance-free
- 40-year warranty
- Robust & Sustainable
- Vertical, horizontal, and diagonal installation
- 3.40" plank



3.40" x 7/16" x 12'





Norwood & Norwood Mini | Cedar

AVAILABLE COLORS

WOOD COLLECTION

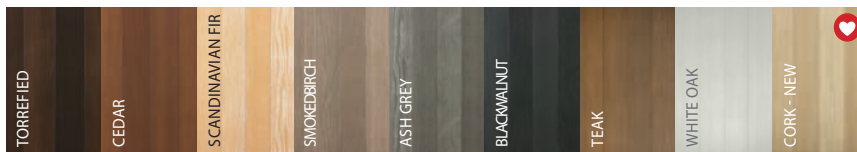

SIGNATURE COLLECTION

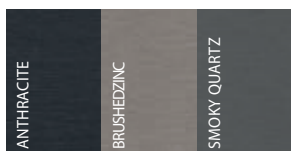

INSPIRATION COLLECTION



HARRYWOOD BLOCK

For a unique touch!



Harrywood Block's clean lines accented with cross grooves give it a distinctive modern finish. Once installed, the look of the profile is reminiscent of slender ceramic blocks, combined with the strength of steel. Harrywood Block offers almost unlimited installation customization options.

You can install it in an aligned joint, offset joint, or broken bond. Plus, it's easy to install vertically, horizontally, and even diagonally.

CHARACTERISTICS

- Maintenance-free
- 40-year warranty
- Robust & sustainable
- Vertical, horizontal, and diagonal installation



6 1/16" x 3/8" x 12'

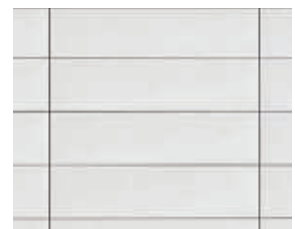

ALIGNED JOINT INSTALLATION



OFFSET JOINT INSTALLATION

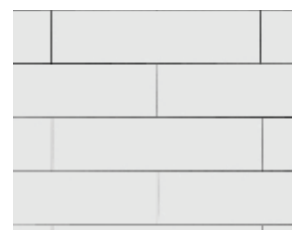

BROKEN BOND INSTALLATION



Harrywood Block | Smoky Quartz

AVAILABLE
COLORS

SIGNATURE COLLECTION

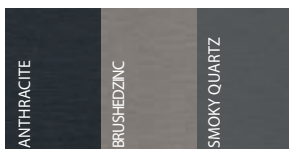

INSPIRATION COLLECTION



POLYMAC

Style and character!



Po l y m a c | S m o k e d B i r c h

Versatile architectural panels

POLYMAC architectural panels combine style, strength, and efficiency. The strength of this panel's design lies not only in its adjustability and flexibility, but also in the complementary accessories available. The Polymac panel is the most effective and affordable alternative on the market.

CHARACTERISTICS

- Steel panel that can be adjusted at the job site
- Predefined format that facilitates the measuring process
- No rail system
- Affordable
- Maintenance-free
- Horizontal installation
- Easy to install
- 40-year warranty
- LEED credit contribution

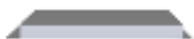

12" x 48" x 1'
12" x 72" x 1'

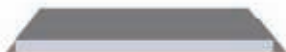

20" x 48" x 1'
20" x 72" x 1'



12" x 12" x 12' x 1'



12" x 12" x 20' x 1'



AVAILABLE COLORS

WOOD COLLECTION



SIGNATURE COLLECTION

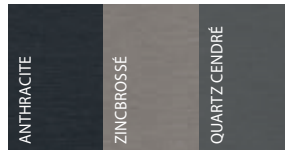

INSPIRATION COLLECTION

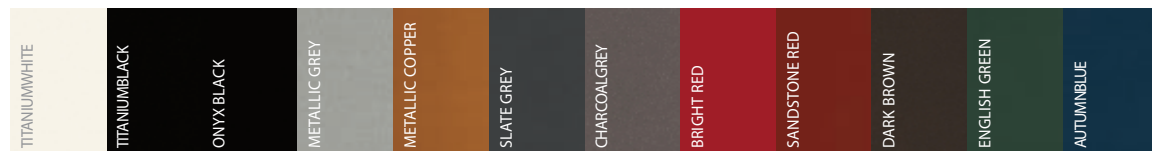

STEEL

an ecological choice

At the center of all trends and innovations, eco-responsibility and sustainable development are the future of construction and renovation. With the passage of time, environmental standards become increasingly important, and companies must aim for more eco-responsible actions. At MAC Metal Architectural, we do not take the environment lightly, and we do everything we can to surpass ourselves in this area that is so important to us. How do we do this? By using products made from recycled materials on your homes! We are proud to say that MAC steel has low toxic emissions and is 100% recyclable at the end of its long life.

Made of 97% recycled steel / 100% recyclable

Contributes to your project's LEED certification







METAL BLOCK

For a unique creation!

This uniquely designed profile with no visible joints perfectly reproduces the look of architectural blocks. Determine the distance between the transverse grooves on your project to leave an incomparable signature. Use them in 12 x 12 size to replicate the look of steel tiles or in 12 x 24 to recreate ceramic blocks — all at a fraction of the cost.

Discover this versatile tile product in its design and installation, which can be installed diagonally, horizontally, and vertically.

CHARACTERISTICS

- Patented profile
- Maintenance-free
- 40-year limited warranty
- No visible joints for a clean, modern look
- Customizable cross-groove distance (12" to 42")
- Vertical, horizontal, and diagonal installation



Metal Block
12" x 1" x 3' @ 60'



AVAILABLE
COLORS

SIGNATURE COLLECTION

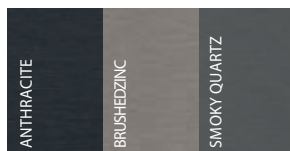

INSPIRATION COLLECTION





VERSA

Class and character!



The Versa cladding brings dynamism and stature to any project thanks to its wider profile. Elegant and refined, it blends in perfectly with the elements that surround it. It's the ideal cladding for those who love large spaces.

CHARACTERISTICS

- Maintenance-free
- 40-year warranty
- No visible joints for a modern look
- 12" profile / plank
- Vertical, horizontal, and diagonal installation



Versa
12" x 1" x 3' @ 60°

AVAILABLE
COLORS

SIGNATURE COLLECTION

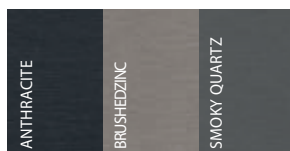

INSPIRATION COLLECTION







8 REASONS
to choose MAC

1 // Highly resistant paint

With Textural III & IV, we offer our customers a unique painting process that provides superior protection against weathering, extreme climatic conditions, and scratches.

2 // 40-year warranty

and an incomparable painting process that ensures longevity and durability, we offer all our customers our 40-year Peace of Mind Guarantee: perfect protection against the distinctive weather and climate of our country.

3 // A plus for your property

With a transferable warranty, MAC steel siding offers a double added value to your property. In addition to significant savings in installation costs, you will increase the value of your home by 6–8%.

4 // An environmentally friendly product

MAC steel siding is one of the premium building products of the new millennium. In addition to containing 97% recycled content, MAC products have low toxic emissions and are 100% recyclable at the end of their life.

5 // Maintenance free

MAC steel siding retains its original appearance and requires little maintenance, so you will be assured of peace of mind for years to come.

6 // Increased resistance to rust

MAC pre-painted galvanized steel products and their textural paint system provide increased rust resistance, making them your best protection against harsh weather conditions.

7 // Superior product

Because performance, efficiency, and customer satisfaction are our primary concerns, we never skimp on quality. We can therefore offer you quality profiles that stand out!

8 // Perfect finish

MAC is THE leader in screwless profiles. You will therefore benefit from top-quality products that add a look of prestige to all the buildings they cover.

MS 1 & MS 2

A continuous line from the roof to the siding!



This triangular pinch strip profile has no visible joints and is a must in the design of living spaces that emphasize clean, flat surfaces. Installed as roofing, siding, or by creating a continuity of perfectly balanced lines from roof to floor, it will give your project a linear and timeless design.

CHARACTERISTICS

- Maintenance-free
- 40-year warranty
- No visible joints for a clean and modern look
- Vertical installation
- MS 1: 19.25" flat surface
- MS 2: 19.25" flat surface with two grooves

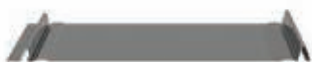

19.25" x 1 1/16" x 3' @ 60'



19.25" x 1 1/16" x 3' @ 60'





MS 1 | Titanium Black

AVAILABLE COLORS

SIGNATURE COLLECTION

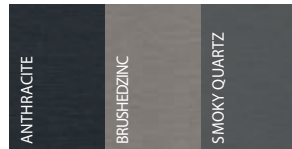

INSPIRATION COLLECTION



MS AUTHENTIC

Historical or contemporary?



This style of profile, with a triangular pinch strip and a flat 19.25" surface, integrates a cross groove every 8 feet. It will blend in with both classic and contemporary architecture, adding charm and distinction. Used as a wall covering, MS Authentic will transform your home by adding prestige.

CHARACTERISTICS

- Maintenance-free
- 40-year warranty
- No visible joints for a sleek, modern look
- Triangular pinch strip
- Cross groove at 8 inches
- Vertical installation
- 19.25" flat surface



19.25" x 1 1/16" x 3' @ 60'





MS Authentic | Metallic Grey

AVAILABLE COLORS

SIGNATURE COLLECTION

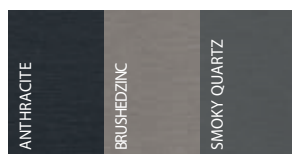

INSPIRATION COLLECTION



MS 1 MODULAR

Beauty in simplicity!



MS 1 Modular | Titanium Black

MS 1 Modular is a triangular pinch strip profile with no visible joints and offers a world of design possibilities. The slender lines and large flat surfaces that characterize this multi-dimensional profile will inevitably lend cachet to your project. With no visible joints, this profile will create a distinct and beautiful effect.

CHARACTERISTICS

- Maintenance-free
- 40-year warranty
- No visible joints for a clean and modern look
- Triangular pinch strip from roof to siding!
- Vertical installation
- MS 1: 19.25" flat surface
- MS 1.1: 15.6" flat surface
- MS 1.2: 11.35" flat surface



MS1
19.25" x 1 1/16" x 3' @ 60'



MS1.1
15.6" x 1 1/16" x 3' @ 60'



MS1.2
11.35" x 1 1/16" x 3' @ 60'





AVAILABLE COLORS

SIGNATURE COLLECTION

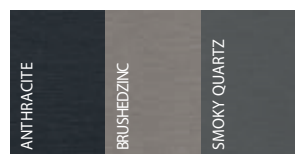

INSPIRATION COLLECTION



MS 3 & MS 4

Harmonious and linear!



MS 3 | Titanium Black

The MS 3 and MS 4 profiles perfectly reproduce the old hand-made siding, thanks to a high-precision profiling technology that ensures a beautiful finish. The profile adds relief and accentuates architectural details. Treat yourself to style and aesthetic!

CHARACTERISTICS

- Maintenance-free
- 40-year warranty
- No visible joints for a clean, modern look
- Profiles with square strips
- Vertical installation
- MS 3: 17.75'' flat surface
- MS 4: 17.75'' flat surface with two grooves



MS 3
17.75'' x 1 1/2'' x 3' @ 60'



MS 4
17.75'' x 1 1/2'' x 3' @ 60'



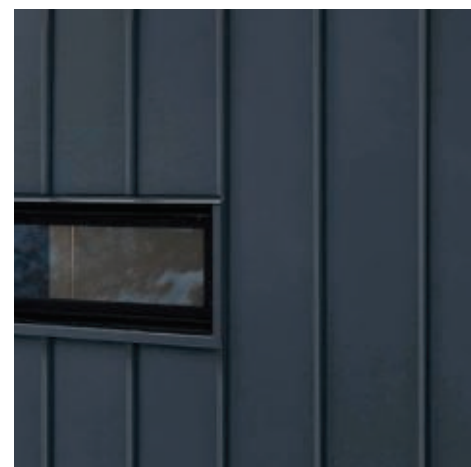

AVAILABLE COLORS

SIGNATURE COLLECTION

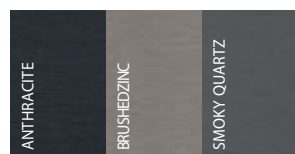

INSPIRATION COLLECTION



MS 380

A touch
of dynamism!



MS 380 & Harrywood |
Dark Brown & Smoked Birch

The soft corrugation of MS 380 Corrugated makes it a perfect modern solution. Unlike traditional corrugated panels that tend to have a more industrial look, the MS 380 has a slight 3/8-inch corrugation that makes it much more refined and versatile. Flexible lengthwise, it allows for some malleability for a curved installation.

As an insert or to create an interesting architectural detail, this siding adds a gentle sinuosity to a building lacking vitality.



21" x 3/8" x 3' @ 60'



AVAILABLE
COLORS

SIGNATURE COLLECTION

ANTHRACITE

ZINCBROSSE

QUARTZ CENDRE

MS 750 & MS 7501

MS 750 | Metallic Grey

Practical and versatile

MS 750 and MS 750 I profiles are economical and robust solutions. Quick to install, they are your best allies for cladding exterior and interior walls and ceilings.





MS 750
20 7/16" x 11/16" x 3' @ 60'

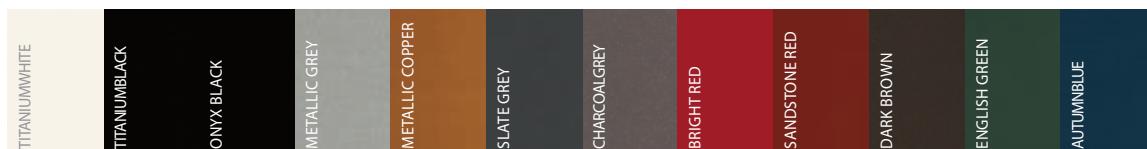

MS 750 I
20 7/16" x 11/16" x 3' @ 60'

INSPIRATION COLLECTION





THE TEXTURAL SYSTEM

Technological performance

MAC's exclusive TEXTURAL III and IV paint processes provide superior protection against extreme weather and climatic conditions.

The constant search for aesthetics and premium quality is part of our DNA, which is why TEXTURAL technology is applied to all our products. Our wide variety of colors creates an unparalleled depth of hue and texture, perfectly reproducing noble materials such as oxidized copper, zinc, and wood, while matte surface finishes eliminate unwanted glare from the sun and provide a clean finish.

TEXTURAL TECHNOLOGY PERFORMANCE UNDER THE MICROSCOPE

- Exceptional corrosion resistance
- Excellent fade resistance
- Superior protection against weathering and extreme climatic conditions
- Scratch and delamination resistance

2x more resistant to UV rays
3x more resistant to corrosion



MAC uses only the most advanced paint technologies in the industry to provide quality cladding that will last for years to come. Our PVDF-based Wood Collection will retain its natural wood look without the worry of maintenance or fading.

- PROTECTIVE COATING**
POLYESTER TYPE
- ZINC COATING G90**
- STEEL SUBSTRATE**
24 OR 26 GAUGE
22 gauge on request
- ZINC COATING G90**
- PRIMER**
Base coat
polyester type



Note that the full range of standard steel colors available on the market can also be ordered upon request. We recommend that you contact your sales representative for availability, quantities, and lead times.

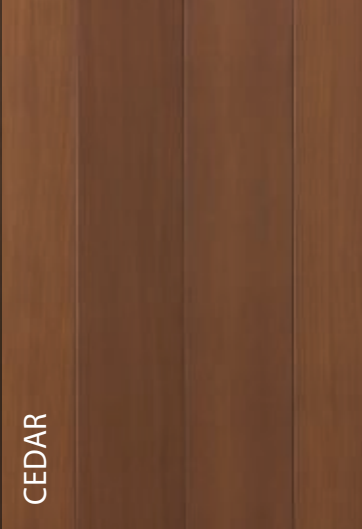

TORREFIED

CEDAR

SCANDINAVIAN FIR

SMOKED BIRCH

ASH GREY

WOOD Collection



ANTHRACITE

BRUSHED ZINC

SMOKY QUARTZ

TITANIUM WHITE

TITANIUM BLACK

SIGNATURE Collection

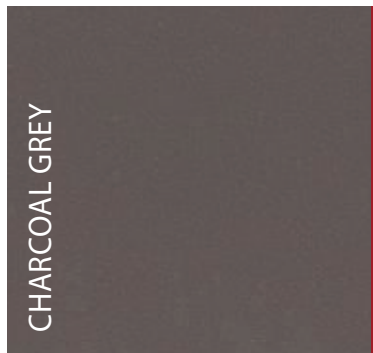

CHARCOAL GREY

BRIGHT RED

OUR COLORS



The colors printed in this brochure are for information purposes only and may vary slightly from the actual color.



BLACK WALNUT

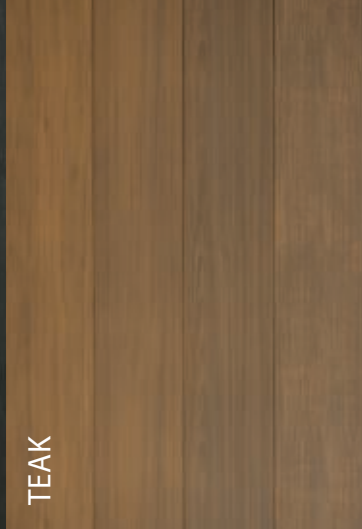

TEAK



WHITE OAK

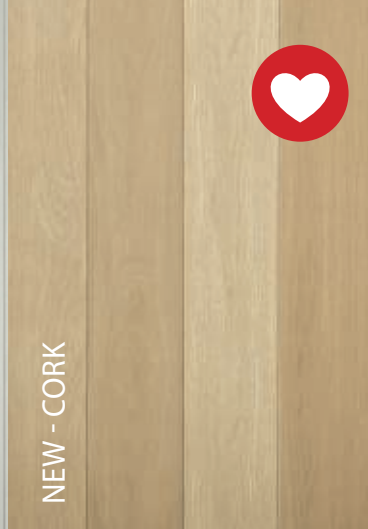

NEW - CORK

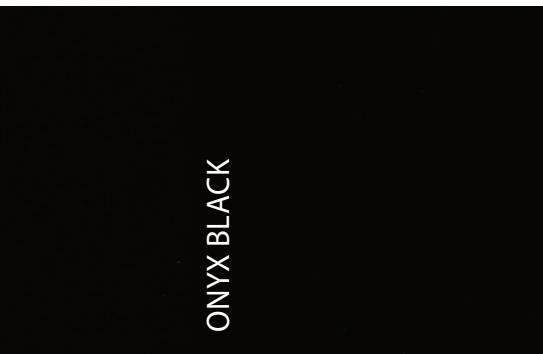

ONYX BLACK



METALLIC GREY



METALLIC COPPER



SLATE GREY



SANDSTONE RED



DARK BROWN

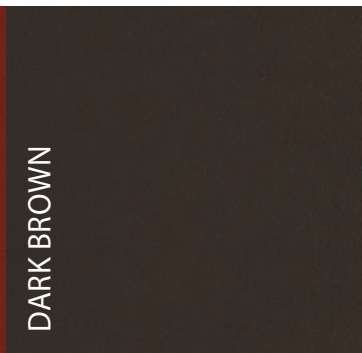

ENGLISH GREEN

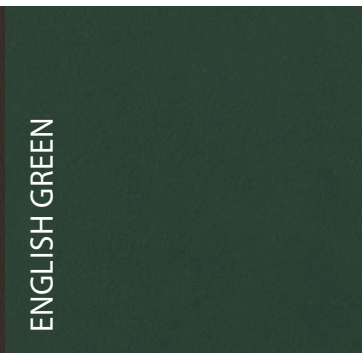

AUTUMN BLUE

INSPIRATION Collection

ACCESSORIES

The detail is in the finishing touch

With an eye for detail, MAC offers a series of accessories that will complement your project perfectly. This will inevitably make heads turn in the neighborhood.

Our profiles are offered with a series of compatible accessories for a perfect finish in every detail. Discover our moldings, soffits, ventilation vents and snow barriers perfectly adapted to our profiles, and all offered in our unique color series.

Clapping Vent



Snow Guard



PEAK



NORTH WEST



Moldings

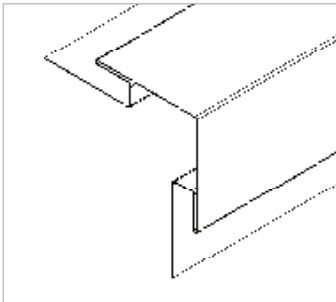

OUTSIDE CORNER

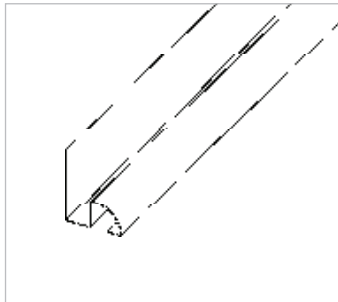

INSIDE CORNER

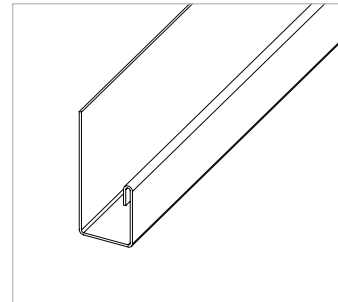

J TRIM

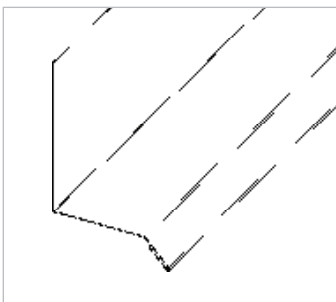

DRIP FLASHING

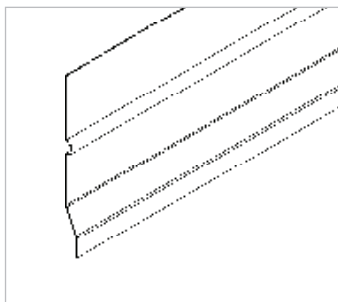

STARTING STRIP



MAC
METAL ARCHITECTURAL

MAC creates products
with bold designs
that blend in with
the environment around them.

MACMETALARCHITECTURAL.COM



5975, chemin de la Savane, Saint-Hubert, QC J3Y 0X1
T 450 464-5486 - info@macmetalarchitectural.com

